

CC26xBxA Bluetooth Smart and IoT Module



Features

- Fully compliant to Bluetooth Low Energy 5.0 (CC264BxA / CC264BxA-S) and 4.2 / 4.1 / 4.0 specifications
- High efficiency on-module printed PCB RF antenna (CC26xBPA / CC26xBPA-S)
- Very few external BOM-count to create a fully functional application circuit
- Texas Instrument CC26xx SimpleLink™ Wireless MCU
- 48MHz ARM Cortex-M3 MCU core for applications with 128K flash memory for ISP
- 8-KB SRAM for Cache and 20-KB Ultra-Low Leakage SRAM
- Dedicated ARM Cortex-M0 core, SRAM, and ROM for RF operations
- Dedicated 16-bit processor and 2KB SRAM for ultra-low power sensor control
- Coin battery-friendly 1.8-3.8V operation
- Ultra Low power consumption, 6.5mA during Active-TX at 0dBm
- Increased modulation index providing possible range of 100m+ in open area
- Continuous Time Comparator and Ultra-Low Power Analog Comparator
- TRNG and AES-128 encryption for data encryption and authentication
- 4 General-Purpose Timer Modules (8 × 16-Bit or 4 × 32-Bit Timer, PWM Each)
- Programmable UART, SPI, I2S, I2C, and GPIO interface
- 12-Bit ADC, 200-ksamples/s, 8-Channel Analog MUX and battery monitor
- Support for 8 Capacitive Sensing Buttons
- Support user-developed applications and custom profile over GATT
- Integrated RF Shield can models available (CC26xBPA-S / CC26xBNA-S)
- Bluetooth Certification BQB: Available upon request
- Approvals: FCC / IC / CE (CC26xBPA-S)
- REACH / RoHS compliant
- Dimensions:
 - 14 x 21.5 x 1.8 mm (CC26xBPA)
 - 14 x 21.5 x 2.6 mm (CC26xBPA-S)
 - 14 x 15 x 1.8 mm (CC26xBNA)
 - 14 x 15 x 2.6 mm (CC26xBNA-S)



Applications

- Internet of Things (IoT) Device
- iBeacon
- Wireless Keyboard and Mouse
- GamePad and Game Controller
- HID applications
- Mobile phone and tablet accessory
- Medical and healthcare monitor
- Sports and Fitness equipment
- Proximity and Lost-prevention Key Fob
- Smart Wearable
- RC and Interactive Toy
- Home/Building Automation
- Machine-to-Machine data transfer
- Remote Sensor Network
- Wireless Alarm and Security
- Automatic Meter Reading (AMR)
- Electronic Shelf Labeling
- Lighting and HAVC control
- Remote Control and Assisted Living

General Electrical Specification

Absolute Maximum Ratings		
Ratings	Min.	Max.
Storage Temperature	-40 °C	+90 °C
Supply Voltage VDD	-0.3 V	3.9 V
Recommended Operating Condition		
Operating Condition	Min.	Max.
Operating Temperature range – (C-grade)	-20 °C	+75 °C
Operating Temperature range – (I-grade) ⁺	-40 °C	+85 °C
Supply Voltage VDD, VDDIO	1.8 V	3.8 V

Parameter	Description	Min.	Typ.	Max.	Units
Operating Frequency		2.4GHz			
Carrier frequency		2379 to 2496 MHz, 1 MHz step 40 channels			
Modulation Method	1Mbps	GFSK, 160/250 KHz deviation			
	2Mbps	GFSK, 320/500 KHz deviation			
Air transmission rate				2	Mbps
RF Output Power		-20	-	3.8	dBm
RX Sensitivity	@0.01% BER		-95.5		dBm
Current Consumption – TX	@ +5dBm	-	9.1	-	mA
Current Consumption – TX	@ 0dBm	-	6.2	-	mA
Current Consumption – RX	Standard	-	5.9	-	mA
Current Consumption – Radio Off	Active	1.6	3.4	-	mA
Current Consumption – Idle	LPM1 Mode	-	0.5	-	mA
Current Consumption – Standby	LPM3 Mode, SRAM/CPU retention and RTC running	-	1	-	uA
Current Consumption – Deep Sleep	LPM4/5 Mode	0.5	0.1	-	uA
Current Consumption – Connected	1 sec Connection Interval, 0dBm		9.8		uA

* Measurements are for CC264BPA

⁺ Contact your GT-tronics sales representative for availability

Standard Firmwares Available

- Heart Rate Monitor (HRP)
- Blood Glucose Monitor
- Health Thermometer (HLP)
- Blood Pressure Monitor (BLP)
- DataExchanger (serial data transfer via GATT)
- Smart Lighting Control (GATT)

Block Diagram

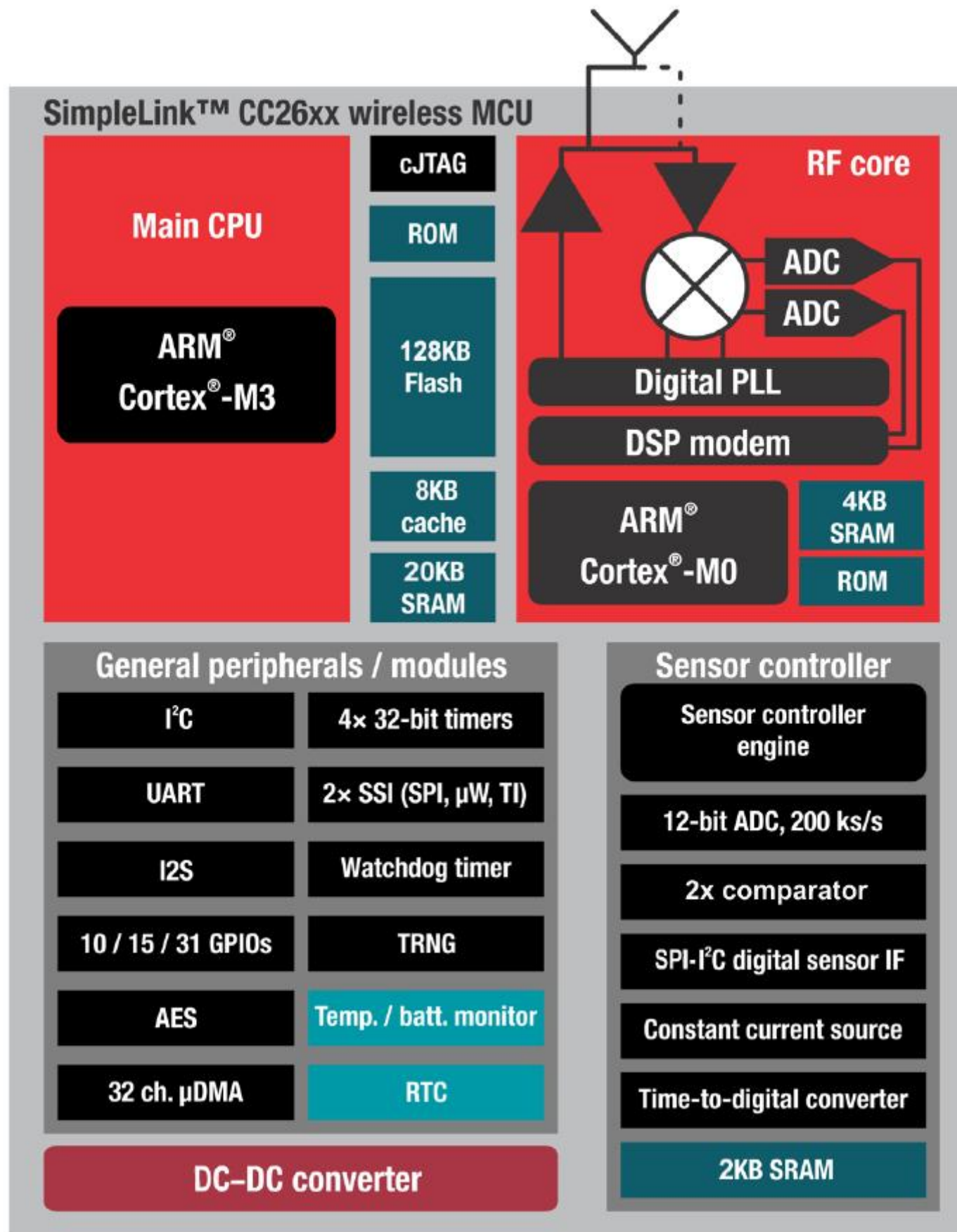

1

Pins Configurations³

PIN	NAME	TYPE	FUNCTION	TYPICAL USAGE ¹
1	GND	Power	Ground	
2	DIO_0	Digital I/O	GPIO with 4mA drive capability	GPIO, Sensor control
3	DIO_1	Digital I/O	GPIO with 4mA drive capability	GPIO, Sensor control
4	DIO_2	Digital I/O	GPIO with 8mA drive capability	GPIO, Sensor control
5	DIO_3	Digital I/O	GPIO with 8mA drive capability	GPIO, Sensor control
6	DIO_4	Digital I/O	GPIO with 8mA drive capability	GPIO, Sensor control
7	GND	Power	Ground	
8	VDD_IO	Power	1.8v to 3.8v GPIO Supply	Connect to VDD
9	JTAG_TMISC	Digital I/O	JTAG TMISC	Debug port data
10	GND	Power	Ground	
11	JTAG_TCKC	Digital I/O	JTAG TCKC	Debug port clock
12	DIO_5	Digital I/O	GPIO with 8mA drive capability	GPIO, JTAG_TDO
13	DIO_6	Digital I/O	GPIO with 8mA drive capability	GPIO, JTAG_TDI
14	VDD	Power	1.8v to 3.8v main power supply	3.3v power input
15	RESET_N	Digital Input	Reset, active-low, no internal pullup	Resistor pull up to VDD
16	DIO_7	Digital/Analog I/O	GPIO with 4mA drive capability, analog	Sensor control, analog
17	GND	Power	Ground	
18	DIO_8	Digital/Analog I/O	GPIO with 4mA drive capability, analog	GPIO, Sensor control, analog
19	DIO_9	Digital/Analog I/O	GPIO with 4mA drive capability, analog	GPIO, Sensor control, analog
20	DIO_10	Digital/Analog I/O	GPIO with 4mA drive capability, analog	GPIO, Sensor control, analog
21	DIO_11	Digital/Analog I/O	GPIO with 4mA drive capability, analog	GPIO, Sensor control, analog
22	GND	Power	Ground	
23	DIO_12	Digital/Analog I/O	GPIO with 4mA drive capability, analog	GPIO, Sensor control, analog
24	DIO_13	Digital/Analog I/O	GPIO with 4mA drive capability, analog	GPIO, Sensor control, analog
25	DIO_14	Digital/Analog I/O	GPIO with 4mA drive capability, analog	GPIO, Sensor control, analog
26	GND	Power	Ground	
27 ²	GND	Power	Ground	
28 ²	RFIN	RF I/O	RF input/output to external antenna	Connect to antenna
29 ²	GND	Power	Ground	

Note:

1. Typical usage is firmware dependent. Please check with standard firmware application note or your firmware designer for the actual pin definition.
2. Available in CC26xBNA versions only.
3. Pin out for CC2640 5x5 RHB IC package.

Module Outline

CC26xBPA / CC26xBPA-S Module Outline

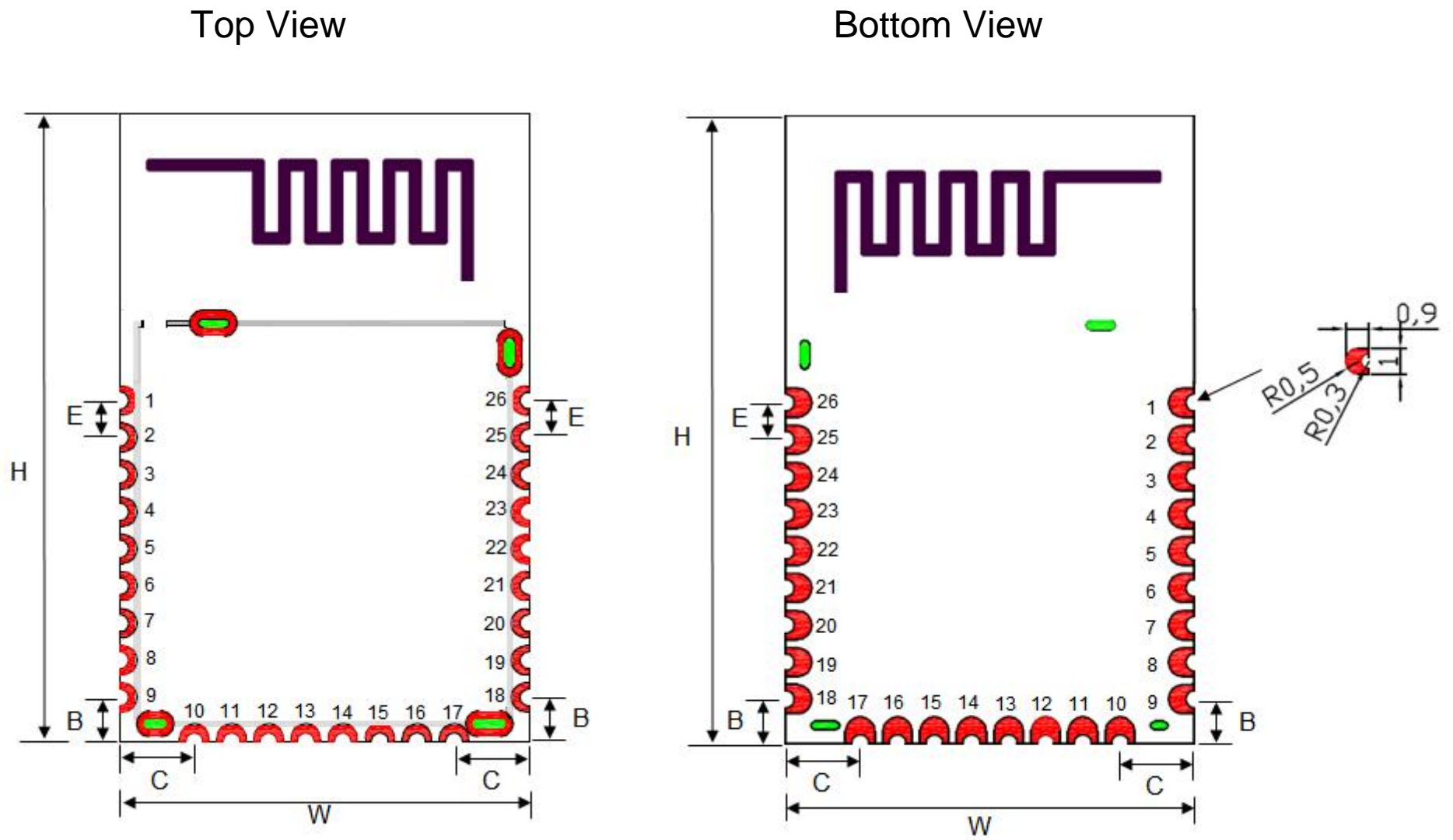

Symbol	Dimension (mm)
B	1.50
C	2.55
E	1.27 (pitch applies to all pins)
W	14.00
H	21.50

CC26xBNA / CC26xBNA-S Module Outline

Top View

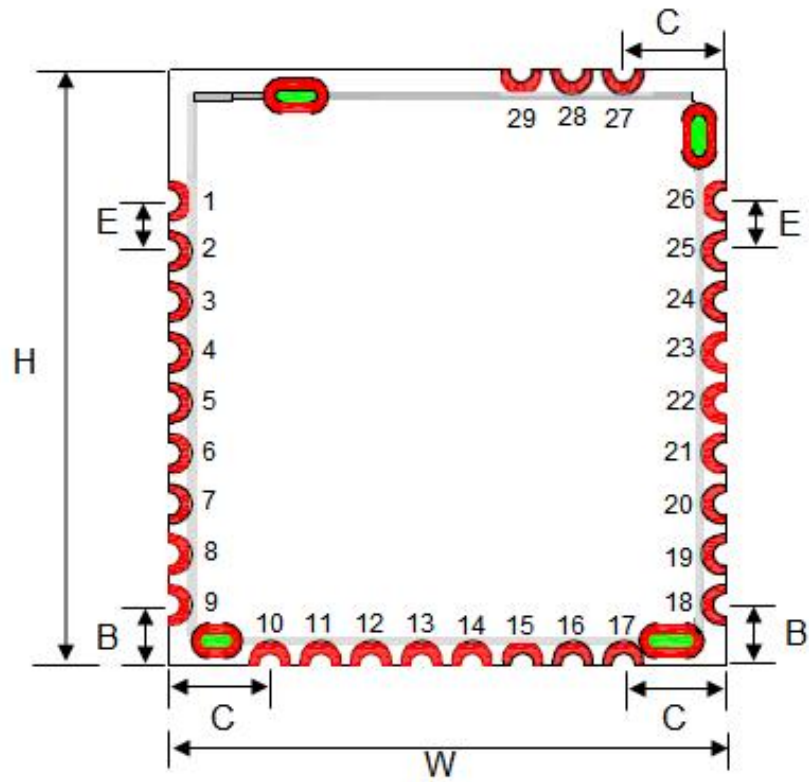

Bottom View

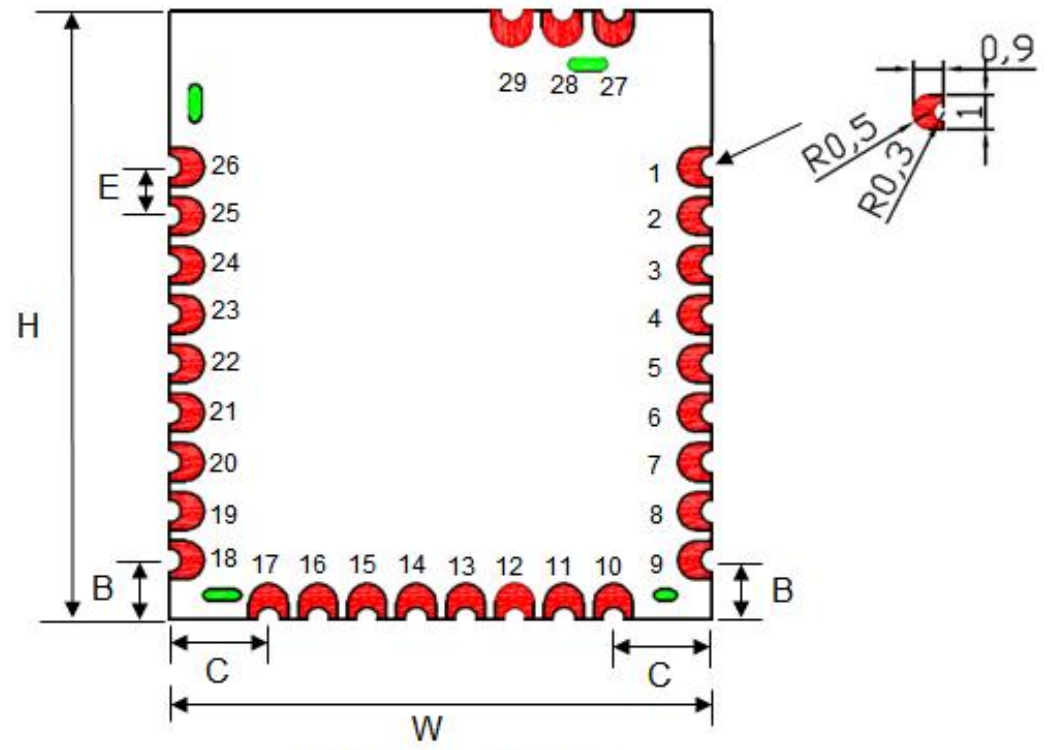

Bottom View

Symbol	Dimension (mm)
B	1.50
C	2.55
E	1.27 (pitch applies to all pins)
W	14.00
H	15.00

* +/- 0.1mm or 1.5% whichever is greater for all module outline measurements.

CC26xBPA-S Physical Dimensions

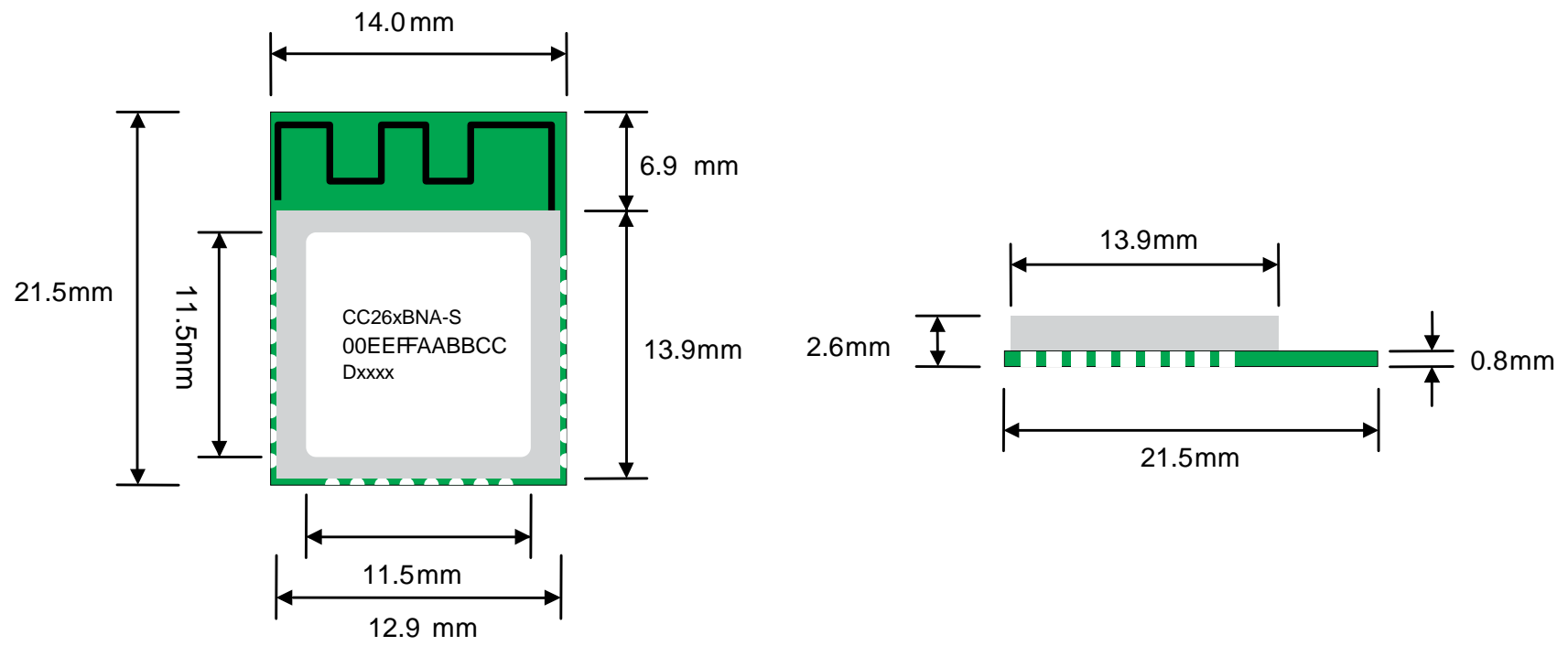

CC26xBNA-S Physical Dimensions

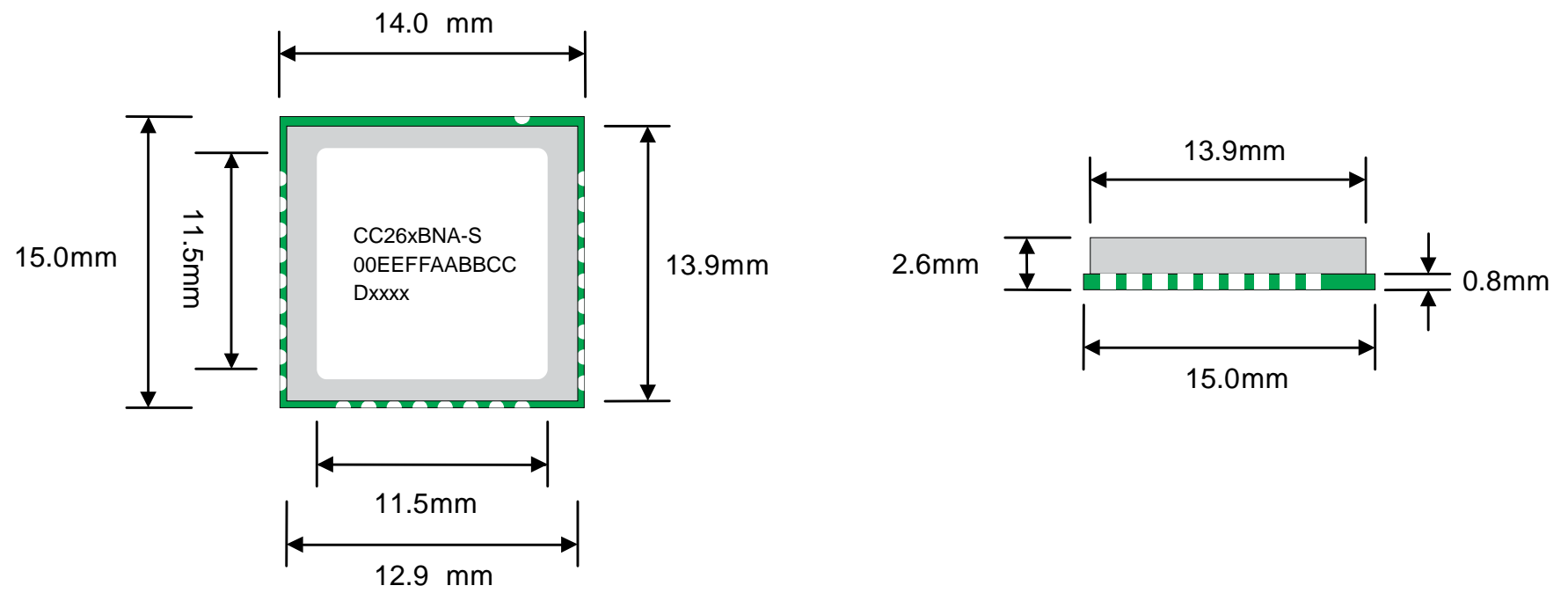

* +/- 0.1mm or 1.5% whichever is greater for all module dimensions measurements.

Recommended PCB Land Patterns

CC26xBPA / CC26xBPA-S Recommended Land Pattern (Top View)

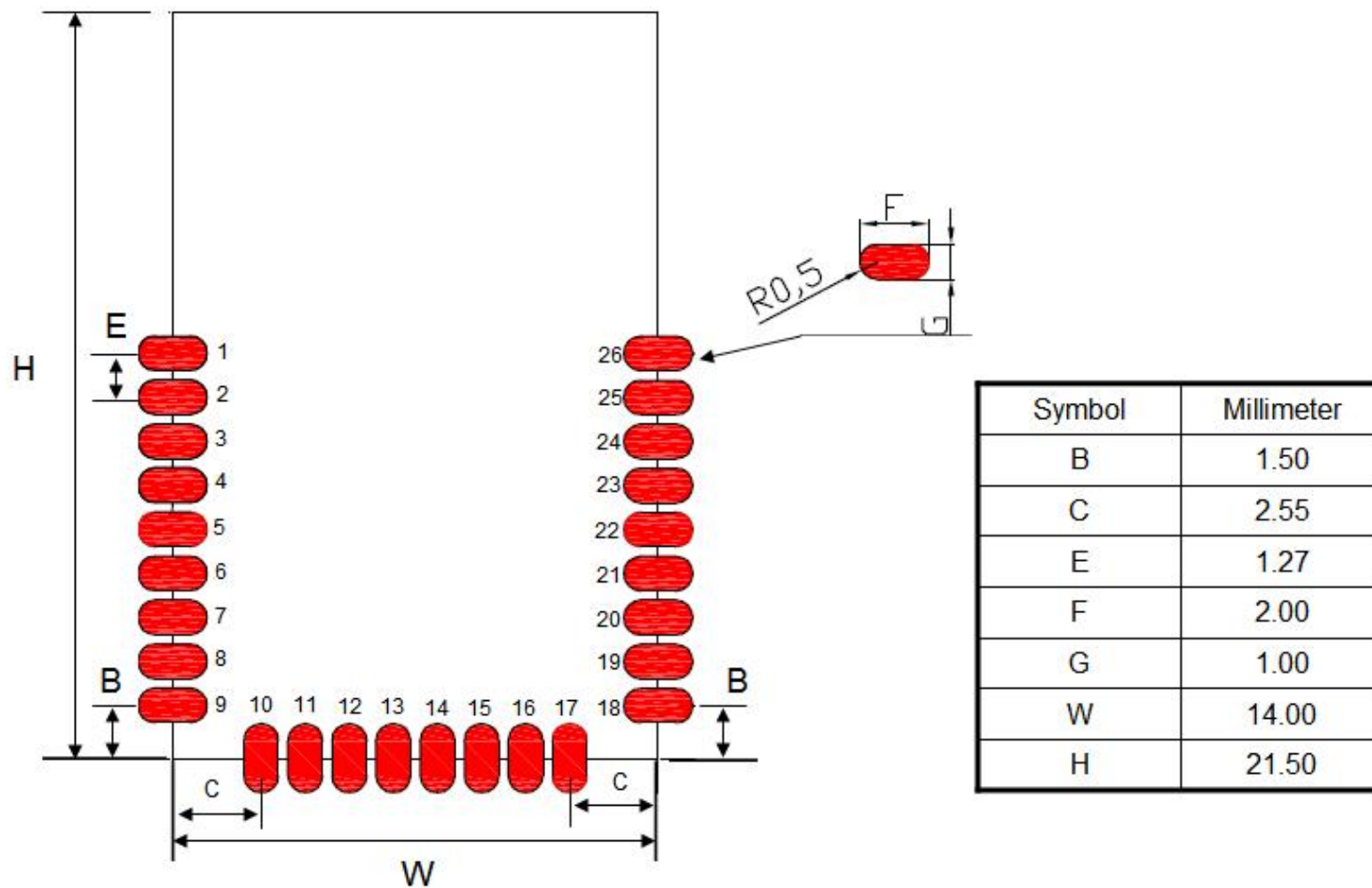

CC26xBNA / C26xBNA-S Recommended Land Pattern (Top View)

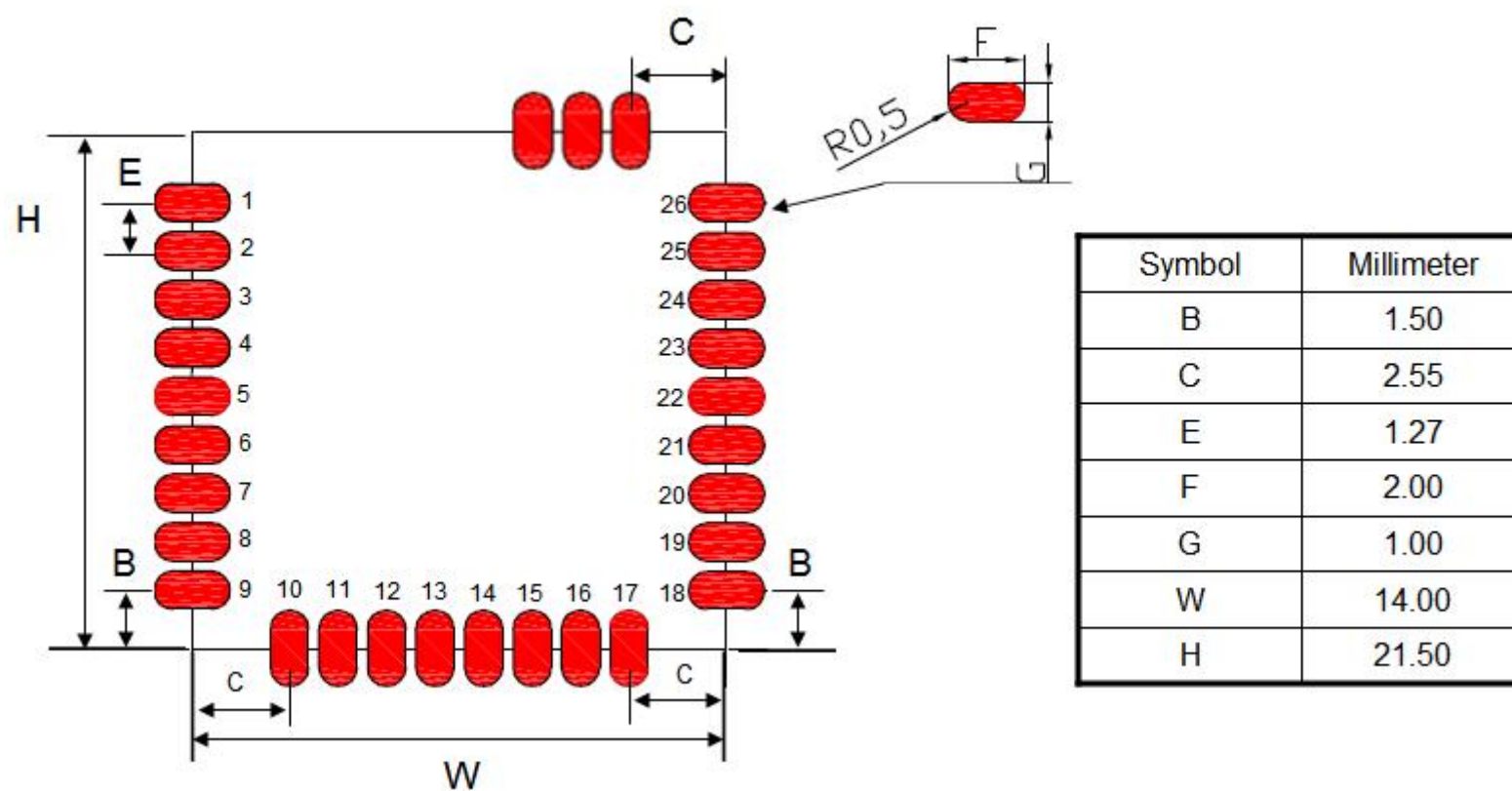

Packing Information

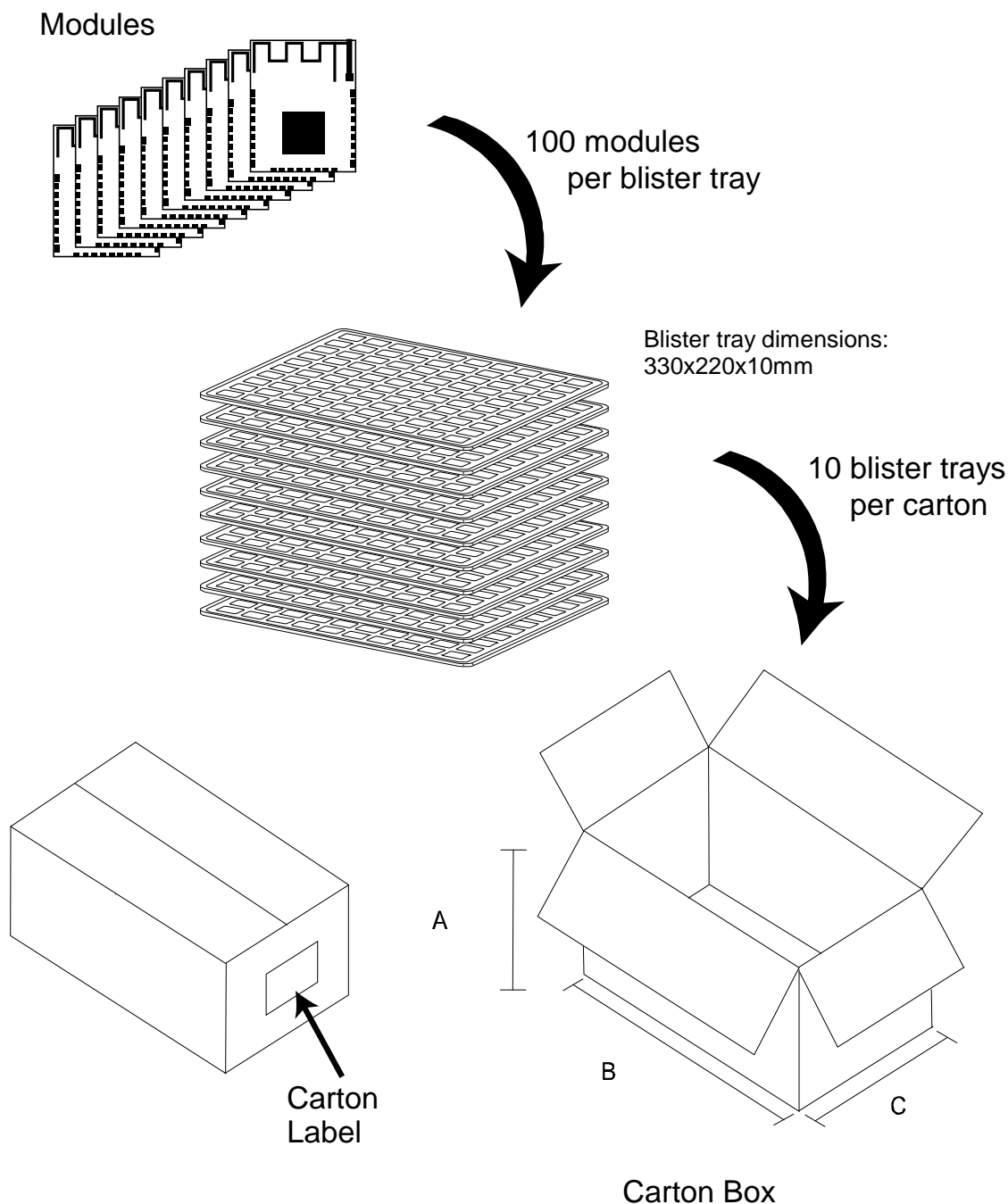

Model	A	B	C	Units	Quantity per Carton	GW / NW
CC26xBPA	11	30	26.5	cm	1000 pcs	1.1 / 0.8 kg
CC26xBPA-S	11	30	26.5	cm	1000 pcs	1.4 / 1.1 kg
CC26xBNA	11	30	26.5	cm	1000 pcs	0.9 / 0.6 kg
CC26xBNA-S	11	30	26.5	cm	1000 pcs	1.2 / 0.9 kg

* +/- 1cm / 0.1kg, or 5% whichever is greater for all packaging measurements.

Precautions

- **Storage Condition**

This product should be stored without opening the packing, and under temperature 0-60 °C and humidity 30-70% RH. It should be used within 15 months after reception.

- **ElectroStatic Discharge (ESD)**

This product is sensitive to ElectroStatic Discharge (ESD). Observe precautions for handling electrostatic sensitive devices. Such precautions are described in the ANSI/ESD S20.20, IEC/ST61340-5, JESD625-A or equivalent standards.

- **Module Reflow Installation**

For RoHS/Pb-free applications, Sn96.5/Ag3.0/Cu0.5 solder is recommended.

Profile Feature	Recommended Parameters
Ramp-up rate before liquidous	< 2°C / second
Preheat	150-200°C 60-90 seconds
Maximum time at liquidous	40 – 80 seconds
Maximum peak temperature	230° - 240°C (below 250°C)
Ramp-down rate	< 6°C / second

Ordering Information

Part Number	FW Code Available	Description
CC264BPA	Please check with your sales rep	CC2640R2F 5x5 with integrated PCB antenna
CC264BPA-S		CC2640R2F 5x5 with integrated PCB antenna and shield can
CC264BNA		CC2640R2F 5x5 (external antenna required)
CC265BPA		CC2650F128 5x5 with integrated PCB antenna
CC265BPA-S		CC2650F128 5x5 with integrated PCB antenna and shield can
CC264BPA-P5	N/A	CC2640R2F 5x5 with integrated PCB antenna (5-pack)
CC264BPA-S5	N/A	CC2640R2F 5x5 with integrated PCB antenna and shield can (5-pack)
CC265BPA-P5	N/A	CC2650F128 5x5 with integrated PCB antenna (5-pack)
CC265BPA-S5	N/A	CC2650F128 5x5 with integrated PCB antenna and shield can (5-pack)

Revision History

Rev.	Date	Description	By
01	2015-01-28	Initial release	Jxwang / Paul
02	2015-03-13	Added module outline drawings and recommended PCB land patterns.	Paul
03	2015-04-23	Editorial modification	Dominic
04	2015-05-19	Updated current consumption data	Paul
05	2016-02-02	Updated pin assignment and product photo	Paul
06	2016-09-08	Updated BLE version and approval information	Dennis
07	2016-12-16	Added ordering information fro CC265BPA	Dominic
08	2017-05-31	Updated BLE core specifications	Dominic
09	2017-07-27	Added new part numbers for multi-pack	Dominic